

PRODUCT CODE

Chrome PW5080CP

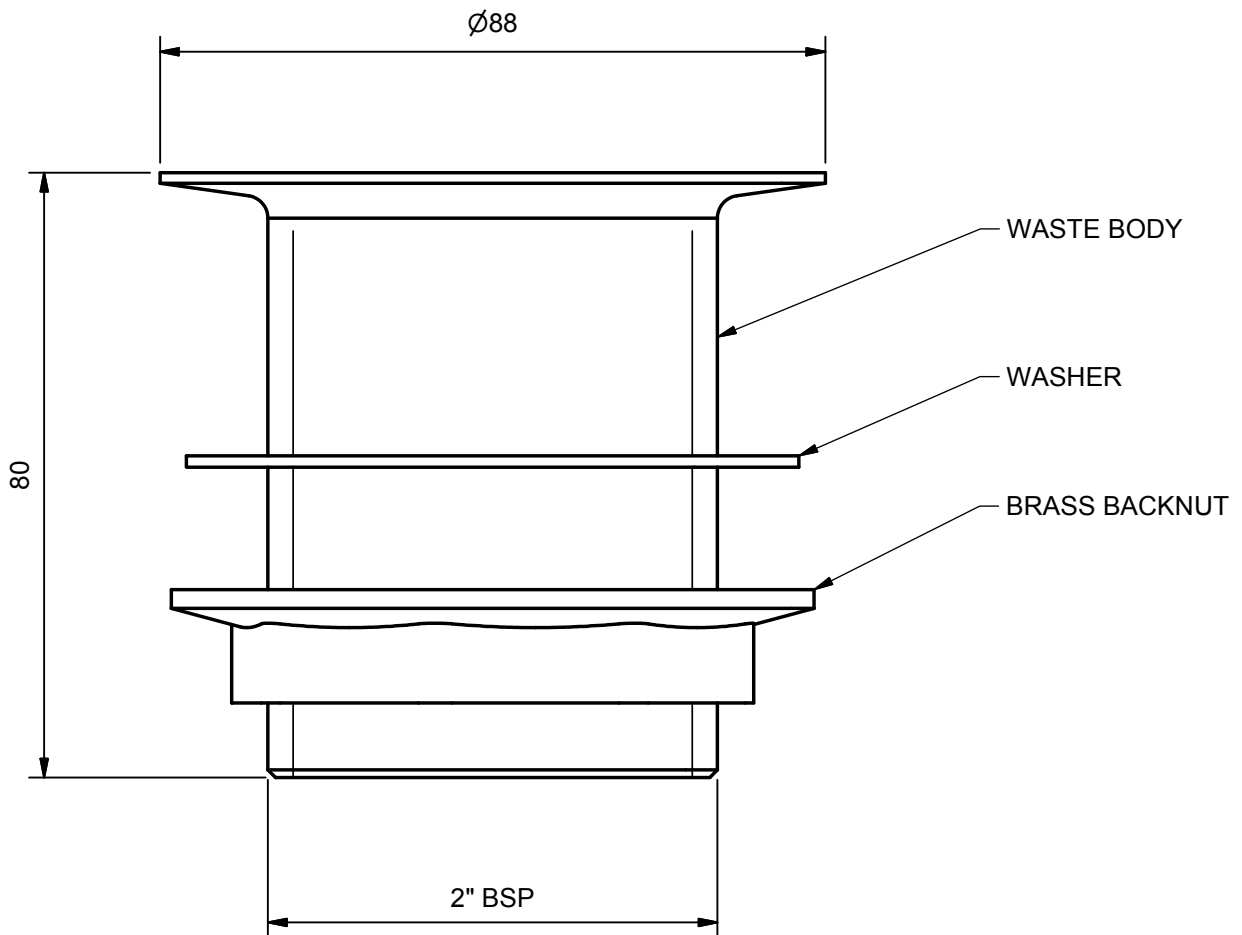
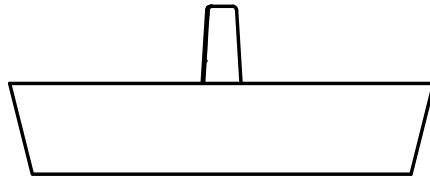
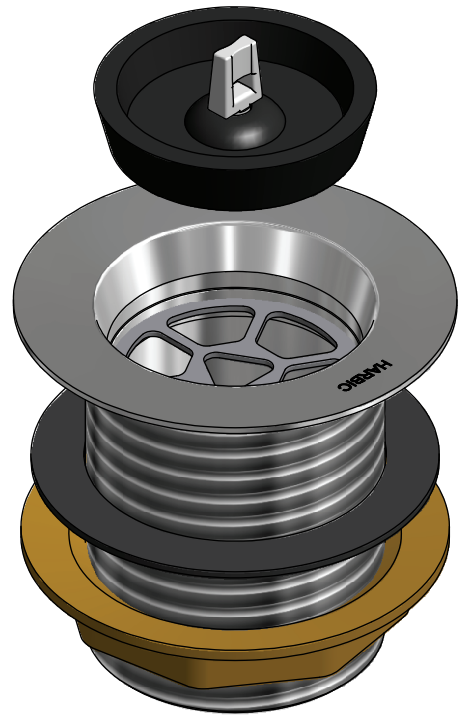

As part of Ramtaps commitment to quality products, Ramtaps reserves the right to alter the design or specification of its products without notice.

RAMTAPS PTY. LTD.
556 Curtin Ave. East. Eagle Farm 4009.
Ph. (07) 3633 6000. Fax (07) 3633 6050.

© 2009 All dimensions in mm.
This drawing remains the property of Ramtaps and should not be copied or distributed without Ramtaps consent.

Title
50mm BATH or SINK WASTE 80mm
TAIL with Brass Backnut & Washer

Code:
PW5080CP

Edition
01

Date of Issue:
14/04/2011